

INSTALLATION *guide*





inteo **CENTRALIS UNO IB**

The **CENTRALIS UNO IB** is a manual individual control of AC motor with link to master control.

- The CENTRALIS uno/IB is compatible with the SOMFY "IB" BUS line (common = +V).
- The CENTRALIS uno/IB has an Integrated switch to disable the master commands.
- Possibility to set one or two intermediate positions.

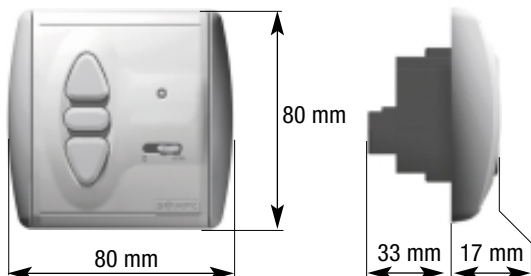
1 Characteristics:



- **Main supply : 220-240V 50Hz.**  EN60730-1
EN50081-1
EN50082-1
- **Class II product** 
- **Protection index IP40.**
- **Output : 250V~ 3A**
- **Output temporisation : activ for 180s.**
- **Environmental conditions for use :**
 - temperature +5°C to +40°C (no condensation allowed).
 - pollution degree typical for usual living space.

2 Installation:

**Installation allowed only by authorized electrician.
Before connecting the unit, read the instructions carefully.**

Cabling

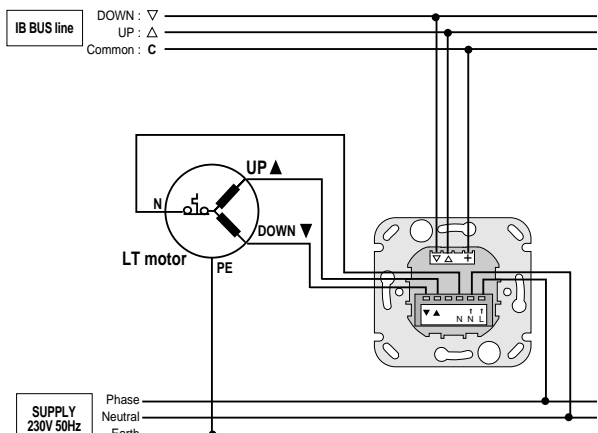

Respect the electrical standards in force as well as the following points:

- disconnect the mains before carrying out any work.
- ensure that no forces act on the screw terminals after installation.
- Do not forget to mount the protection cover to separate the cables for the BUS line and the cables for the power supply.



Mounting

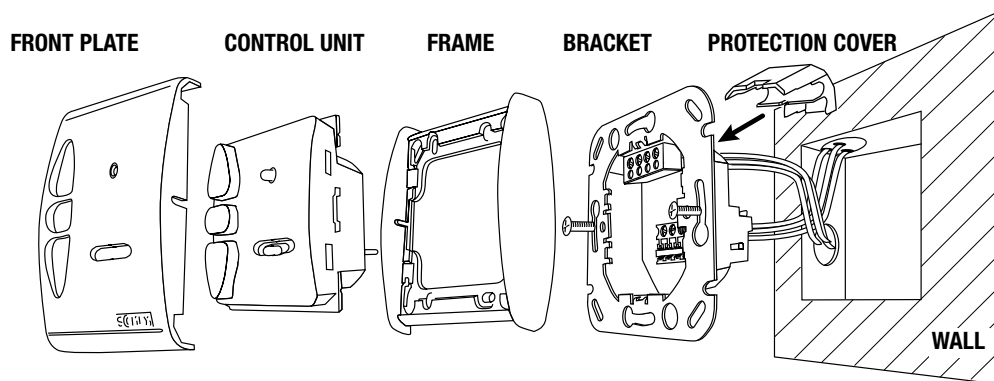

Do not forget to mount the protection cover to separate the BUS line and the power supply.

3 Using:

UP/DOWN/STOP Commands



“0 / auto” switch

“auto” position :

the local and the master “commands” from the BUS line are taken into account.

“0” position :

Only the local commands are taken into account and the master commands which come from the BUS line are disabled. Then, to force the control of the **CENTRALIS uno IB** from the BUS line, the command should be longer than 2 sec.

→ The LED lights on in red when a command longer than 2 sec. is given on the BUS line.

Intermediate position

With the CENTRALIS uno IB, it is possible to set one or two intermediate positions (IP) : one accessible from the top of the roller shutter (IP1) and one from the bottom (IP2).

To record these positions, the CENTRALIS uno IB has to record the time for the roller shutter to go from its top to the IP and also the time from its bottom one to the IP.

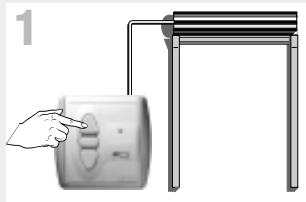

Note : The intermediate positions can only be recorded and reached from the local push buttons.

Record the IP1 from the top of the roller shutter

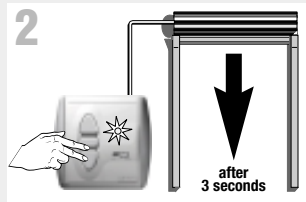

- Set the shutter at its **UP** limit with the  push button.



- Push simultaneously on the  and  button until the LED lights on in "green".
The shutter begins to move down.

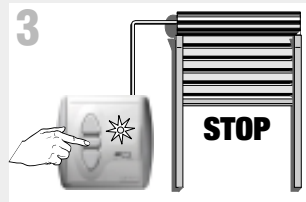

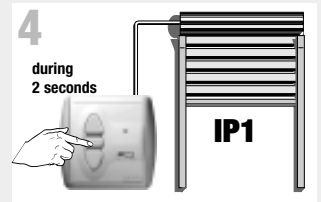

- Stop the shutter at the intermediate position you wish. If necessary, adjust this position with the push buttons.



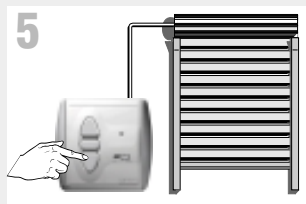

- Push the  button more than 2 sec.
⇒ *The LED lights off, the CENTRALIS Uno/IB has memorized the 1st intermediate position.*

Record the IP2 from the bottom of the roller shutter

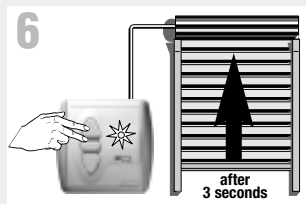

- Set the shutter at its **DOWN** limit with the  push button.



- Push simultaneously on the  and  button until the LED lights on in "green".
The shutter begins to move up.

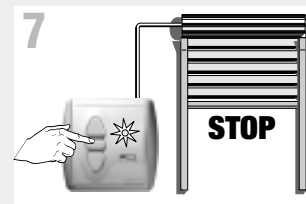

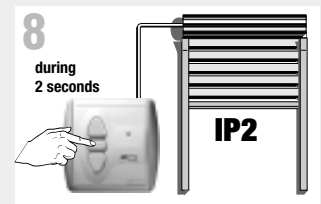

- Stop the shutter at the intermediate position you wish. If necessary, adjust this position with the push buttons.

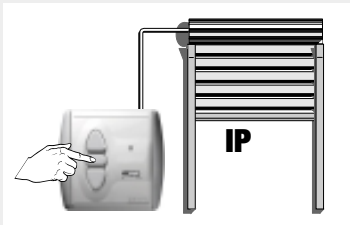

- Push the  button more than 2 sec.
⇒ *The LED lights off, the CENTRALIS Uno/IB has memorized the 2nd intermediate position.*

Reach the intermediate positions



- IP1** : press briefly the  button while the shutter is at its **UP** limit.
- IP2** : press briefly the  button while the shutter is at its **DOWN** limit.
- ⇒ *The shutter will move and stop at the dedicated intermediate position.*

Delete an intermediate position



- To delete an intermediate position, reach the intermediate position you wish to delete, then press continuously the IP button until the led lights on in "red"(approx. 8 sec.).
⇒ *The concerned IP is deleted.*

CABLING OF SEVERAL CONTROL POINTS FOR SEVERAL MOTORS

CENTRALIS UNO IB with CENTRALIS IB

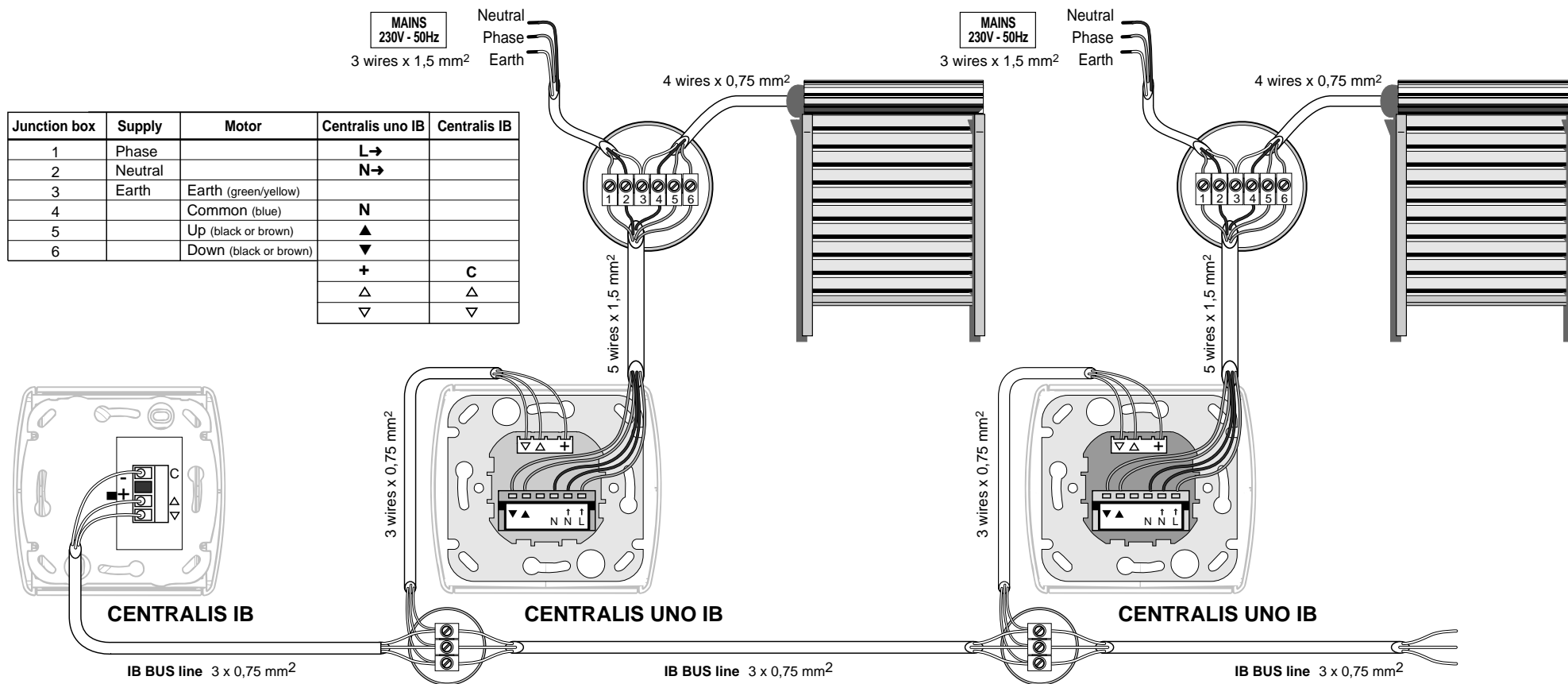

Set the switch of the CENTRALIS IB on the “+” position.

